

EASY TO ASSEMBLE KITS AND PREMIUM QUALITY COMPONENTS



EXTERIOR

Clearview



INTERIOR

Axxys™

Our Company

With over three decades of experience, BW Creative Wood Industries Ltd is one of the world’s leading manufacturers of railing systems, components and accessories. With an international reputation for quality and innovative customer solutions, our focus is on providing our partners with a complete customer solution. This is a dynamic experience that begins with being customer focused. Through building a deep understanding of our customers and their unique businesses we can bundle our products and services to provide individually customized solutions to help our customers achieve greater success. Staying focused on railings while working across international markets and with market leading customers provides us with unique insight into emerging trends and innovations. We are uniquely positioned as a manufacturer and supplier of both interior and exterior railings and thereby able to offer superior solutions and products to our customers.

TRADITIONAL.....	4	WESTERN RED CEDAR.....	12
TUSCANY.....	5	TREATED PINE.....	14
CLEARVIEW.....	6	EXTERIOR PRIMED.....	16
SEEMORE.....	8	INTERIOR AXXYS™.....	18
VENETIAN.....	9	HEMLOCK.....	20
ACCESSORIES.....	10	INTERIOR FASTENERS.....	21
PORCH POSTS.....	11	MERCHANDISING RACKS.....	22



Our Products

Under the brand name RAIL SIMPLE, BW Creative Wood Industries Ltd offers an industry leading range of interior and exterior railing systems, components and accessories. Whether you are looking for the versatility of clear hemlock, the timeless beauty of oak, the natural warmth of western red cedar, the rustic charm of treated lodge pole pine, or the time savings of pre-primed, the premium quality of our products is always on display.

One of the product lines that sets RAIL SIMPLE apart is our Railing Kits. Offered for both interior and exterior application, RAIL SIMPLE railing kits provide time savings in a box. This moves well beyond simply packing components in a box.

We pre-select premium rail to eliminate call backs, we profile and pre-drill the railing for quick assembly eliminating the need for measuring baluster spacing, drilling holes or attaching connectors and we include quick mount rail brackets with screws to simplify the whole process. Railing Kits are installed in minutes not hours. Simple to buy, simple to install, simply beautiful.

We provide you with the key selling SKUs. From contemporary to traditional, from metal to wood, from components to kits and all the accessories, we offer superior solutions to help you achieve success.

The Environment

While our certification to standards set by the Forest Stewardship Council (FSC) and the international Program for Endorsement of Forest Certification (PEFC) shows our commitment to the environment, the fact that we were the first in our industry to be FSC certified some 15 years ago shows that it is in our roots. We utilize wood in our railing systems not just for its warmth, beauty and strength but also because it is the most environmentally logical choice as the most renewable, re-useable and recyclable resource we have today. Wood is nature's most infinite, sustainable, least energy consumptive material. It is our responsibility to make wood a major part of our product lines.

Please visit us at:
www.railsimple.com

TRADITIONAL RAILING KITS & COMPONENTS

6' & 8' RAILING KITS
(Net railing lengths of 71½" or 95½")

**Complete Railing
Section In A Box**

EACH RAILING KIT CONTAINS:

- 1) 2 pieces of Beautifully Profiled & Pre-Drilled Rails (available in 71½" or 95½")
- 2) Set of Powder-coated Metal Balusters (Actual size: 26" or 32")
- 3) 2 Pair of Rail Hanger Brackets (4 rail hangers with screws)
- 4) Easy to follow installation instructions.

VISIT WWW.RAILSIMPLE.COM FOR
INSTALLATION INSTRUCTIONS



Railing Kit



KITS

6 ft Treated 26" Black Traditional Balusters
6 ft Cedar 26" Black Traditional Balusters
8 ft Treated 32" Black Traditional Balusters

Order Code BWC SKU	Unit Qty.	Pallet Qty.
CRTRT6B26I	Kit	48
CRWRC6B26I	Kit	48
CRTRT8B32I	Kit	48

*For 36" Railing height use cap rail with 26" Balusters
For 42" Railing height use cap rail with 32" Balusters
Cap rail sold separately (Treated AT200IS08A or
Treated AT201ZS08A or Cedar CE201HS08A) see page 12 & 14*

BALUSTERS ONLY

26" Black Traditional Balusters
32" Black Traditional Balusters

Order Code BWC SKU#	Unit Qty	Ctn Qty	Pallet Qty
AL9300B26W	ctn	10 pcs	198
AL9300B32W	ctn	10 pcs	198

RAILING-PRE-DRILLED FOR RAILSIMPLE BALUSTERS

1-7/16 x 3-3/8 x 8 ft Cedar Pre-drilled & Profiled Rail
1-7/16 x 3-3/8 x 8 ft Treated Pre-drilled & Profiled Rail

Order Code BWC SKU#	Unit Qty	Ctn Qty	Pallet Qty
CE279/S08L	pc	6 pcs	216
AT279/S08L	pc	6 pcs	216

RAIL HANGER BRACKET

Rail Hanger Bracket - Black

Order Code BWC SKU#	Unit Qty	Bag Qty	Pallet Qty
HW9509600W	bag	2	2,000

DECORATIVE BALUSTER COLLARS

Spiral Collar - Black
Ring Collar - Black

Order Code BWC SKU#	Unit Qty	Pack Qty	Pallet Qty
AL9310B00W	pack	1	480
AL9320B00W	pack	2	660



Balusters
only box

6' & 8' RAILING KITS
(Net railing lengths of 71½" or 95½")

**Complete Railing
Section In A Box**

EACH RAILING KIT CONTAINS:

- 1) 2 pieces of Beautifully Profiled & Pre-Drilled Rails (available in 71½" or 95½")
- 2) Set of Powder-coated Metal Balusters (Actual size 32" or 27" on stair balusters)
- 3) 1 Horizontal Lockbar
- 4) 2 Pair of Rail Hanger Brackets (4 rail hangers with screws)
- 5) Easy to follow installation instructions.

TUSCANY RAILING KITS & COMPONENTS

VISIT WWW.RAILSIMPLE.COM FOR
INSTALLATION INSTRUCTIONS

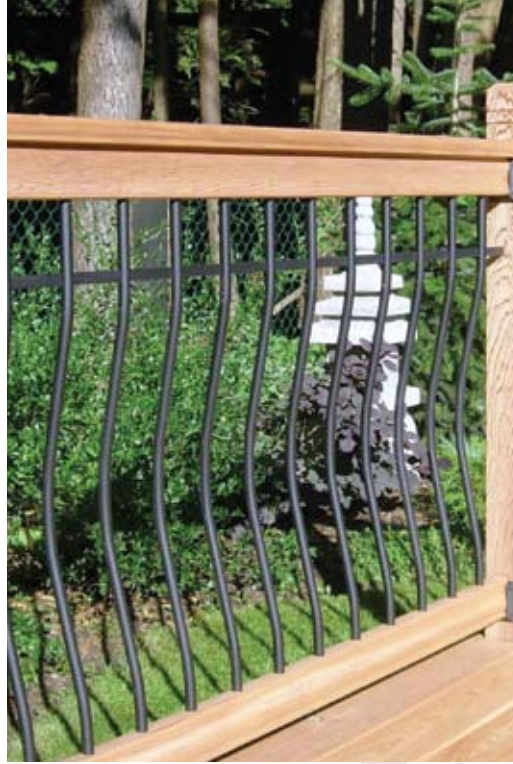

Railing Kit

BlueLinx

KITS

- 6 ft Treated 32" Black Tuscan Balusters
- 8 ft Cedar 32" Black Tuscan Balusters
- 8 ft Treated 27" Black Tuscan STAIR Balusters
- 8 ft Cedar 27" Black Tuscan STAIR Balusters

Order Code	Unit	Pallet
BWC SKU#	Qty	Qty
TRTRT6B32I	Kit	48
TRWRC8B32I	Kit	48
TSTRT8B27I	Kit	48
TSWRC8B27I	Kit	48

For 42" Railing height use cap rail with 32" Balusters
For Stair Railing height of 37.5" use cap rail with 27" Balusters
Cap rail sold separately (Treated AT201ZS08A or Cedar CE201HS08A) see page 12 & 14

BALUSTERS ONLY

- 32" Tuscan Black Balusters
- 27" Tuscan Universal **Stair** Baluster Black

Order Code	Unit	Ctn	Pallet
BWC SKU#	Qty	Qty	Qty
AL9500B32W	ctn	10	88
AL9503B27W	ctn	10	88

LOCK BAR

- 8 ft Black Lock Bar

AL9600B08W	bag	4	200
------------	-----	---	-----

**RAILING-PRE-DRILLED FOR
RAILSIMPLE BALUSTERS**

- 1-7/16 x 3-3/8 x 8 ft Cedar Pre-drilled & Profiled Rail
- 1-7/16 x 3-3/8 x 8 ft Treated Pre-drilled & Profiled Rail

Order Code	Unit	Ctn	Pallet
BWC SKU#	Qty	Qty	Qty
CE279/S08L	pc	6 pcs	216
AT279/S08L	pc	6 pcs	216

RAIL HANGER BRACKET

- Rail Hanger Bracket - Black

Order Code	Unit	Bag	Pallet
BWC SKU#	Qty	Qty	Qty
HW9509600W	bag	2	2,000



Balusters
only box

CLEARVIEW RAILING SYSTEM

(2 box system)

VISIT WWW.RAILSIMPLE.COM FOR
INSTALLATION INSTRUCTIONS

Color Coded boxes
A simple box coding system using color bands with letters provides a clear concise method for purchasing this two (2) box railing system.

For 36" Railing height:

A 3 piece railing kit
+

C 7 glass panels

For 42" Railing height:

A 3 piece railing kit
+

D 7 glass panels

For stairs:

B stair railing kit
+

E 6 glass panels



Glass panels

Railing

TEMPERED SAFETY GLASS PANELS

7 glass panels per box (stair glass = 6 panels per box)

- Clear tempered Glass Panels for 36" railing height (actual panel 5/16" x 6" x 26-1/4")
 - Clear tempered Glass Panels for 42" railing height (actual panel 5/16" x 6" x 32-1/4")
 - Clear tempered Glass Panels for stair railing (actual panel 5/16" x 6" x 33-1/16")
- NB: Angled Stair glass panels = 32.5°

Order Code BWC SKU	Pcs per Ctn.	Boxes per Pallet	Color Coded Box Letter
GL9000C26W	7	20 boxes	C
GL9000C32W	7	20 boxes	D
GL9000C33H	6	20 boxes	E

CLEARVIEW RAILING – PRE-SLOTTED & PRE-ENGINEERED

[Each railing kit includes 2 (net 71-1/4") pre-slotted top & bottom rails, one (net 71-1/2") contemporary cap rail & two pair of hanger brackets and screws.]

- 6 ft. Premium Clear Western Red Cedar Deck Railing Box (3 pcs.)
- 6 ft. Premium Clear Western Red Cedar Stair Railing Box (3 pcs.)
- 6 ft. Premium Treated Deck Railing Box (3 pcs.)
- 6 ft. Premium Treated Stair Railing Box (3 pcs.)

CVWRCCP06I	3	66 boxes	A
CVWRCCS06I	3	66 boxes	B
CVTRTCP06I	3	66 boxes	A
CVTRTCS06I	3	66 boxes	B

CLEARVIEW INSTALLATION

Clearview has been designed to offer a clear unobstructed view of your great outdoors. Made with 5/16" clear tempered safety glass, Clearview is 25% thicker than typical glass railing sections.

This stronger glass is surrounded with a revolutionary new railing system offering the ultimate in simplicity and low maintenance. This unique and innovative railing system allows you to simply place the 6" wide glass panels into the pre-engineered rail slots. The warmth and beauty of clear western red cedar with clarity of tempered glass. Seven rail slots, seven glass panels, six on stair kits. It's that easy.

1 Install newel posts

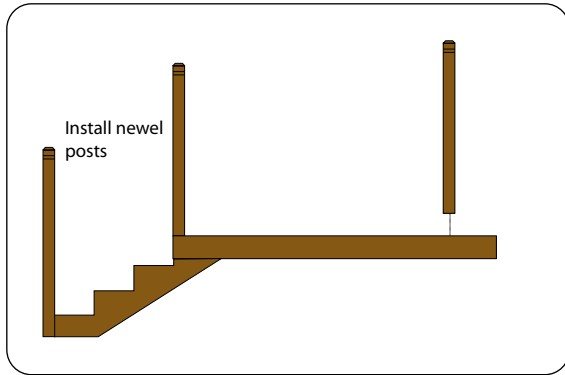

2 Install bottom rails

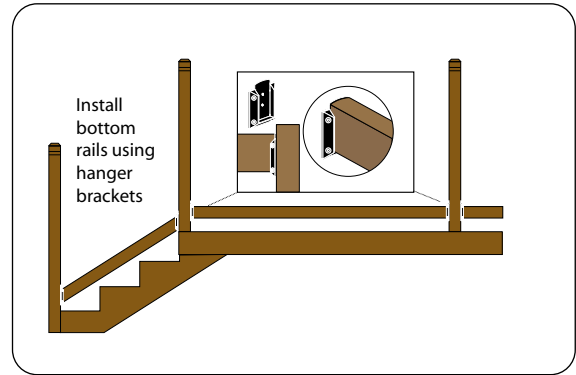

3 Install glass

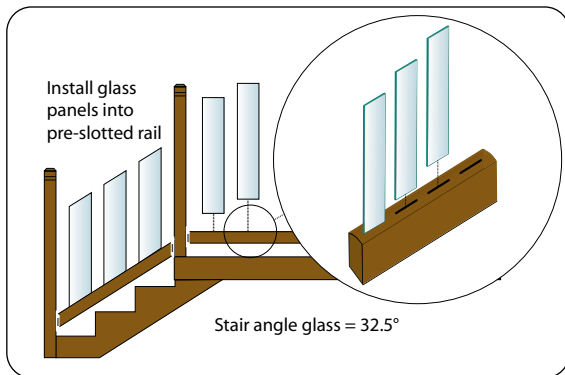

4 Install pre-slotted top rails & cap rails

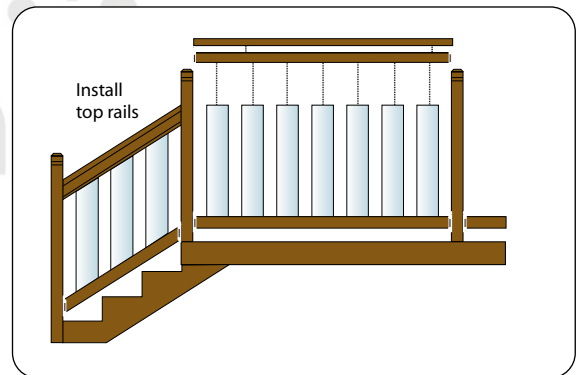

CUTTING GUIDE

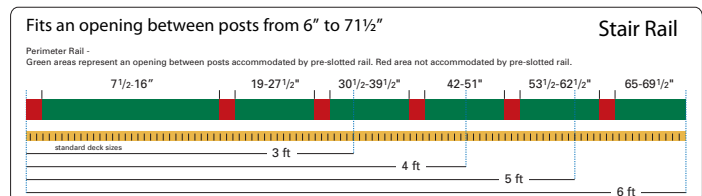
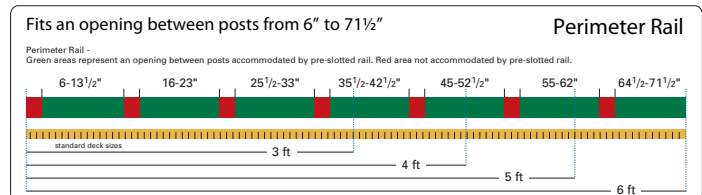

SEEMORE BALUSTERS

Seemore architectural balusters are beautifully curved, powdered coated, and are narrow profiled to enhance your view through the railing.



BALUSTERS FOR 36" RAILING HEIGHT

10 balusters = approx. 4 ft
Seemore Black Balusters - 11/16" x 31"

Order Code	Unit	Box	Pallet
BWC SKU#	Qty	Qty	Qty
AL9700B31W	box	10	96

RAIL HANGER BRACKET

Rail Hanger Bracket - Black

Order Code	Unit	Bag	Pallet
HW9509600W	bag	Qty	Qty
		2	2,000

1 Install newel posts

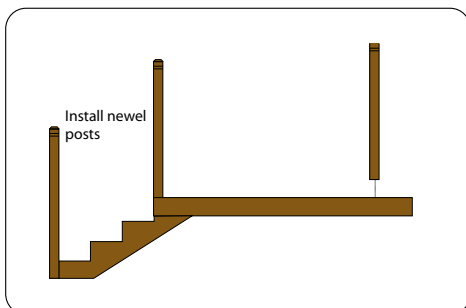

2 Install bottom and top rails

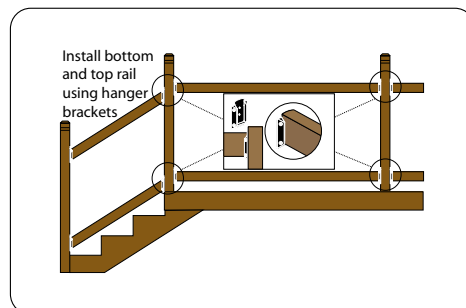

3 Screw balusters onto rail face

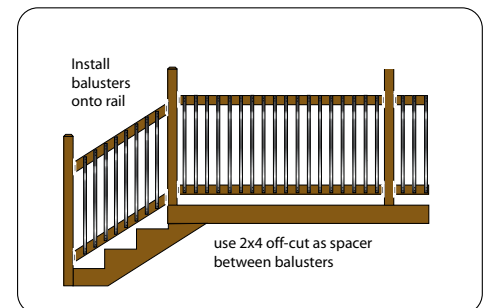

Venetian architectural balusters make a bold, beautiful statement with their extra wide profile and curved shape. Venetian balusters are designed to replace worn angle cut wooden balusters and instantly upgrade your outdoor living room.

VENETIAN BALUSTERS



BlueLinx

BALUSTERS FOR 36" RAILING HEIGHT

6 balusters = approx. 3 ft
Venetian Black Balusters - 1-1/2" x 42"

Order Code	Unit Qty	Box Qty	Pallet Qty
BWC SKU# AL98000B42W	box	6	80

RAIL HANGER BRACKET

Rail Hanger Bracket - Black

Order Code	Unit	Bag Qty	Pallet Qty
HW9509600W	bag	2	2,000

1 Install newel posts

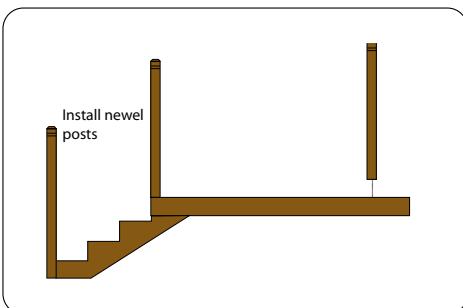

2 Install top rails

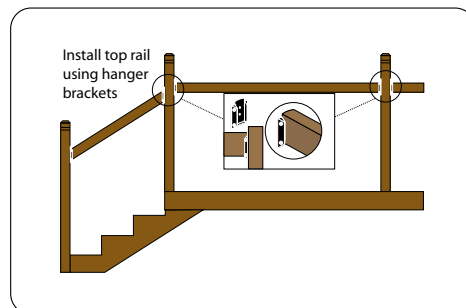

3 Screw balusters onto rail and deck

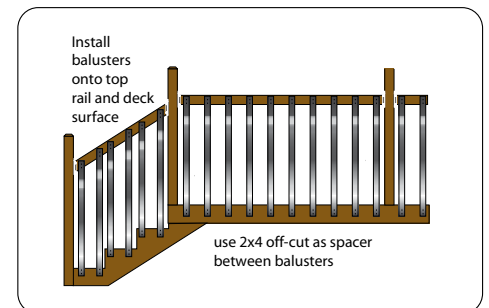

Rail Simple fasteners, connectors and supports are all specifically designed to simplify the installation process saving you time and money. Rail Simple decorative accents are designed to inspire a variety of new deck railing options allowing you to create a truly distinctive and unique railing design. Simple is beautiful.

Decorative baluster collars simply slide over RAIL SIMPLE powder-coated balusters and are fixed in place with the turn of the set screw. Mix and match to create drama or old world charm on your railing.



Decorative Baluster Collar - Spiral



Decorative Baluster Collar - Ring

RAIL HANGER BRACKET

Rail Hanger Bracket - Black
(2 brackets with stainless steel screws)

Order Code BWC SKU#	Unit Qty	Bag Qty	Pallet Qty
HW9509600W	bag	2	2,000

BALUSTER CONNECTORS

attaches to rail with screws

Baluster Connectors (includes stainless steel screws)
Baluster Stair Connectors (includes stainless steel screws) Black

AL9401000W	bag	20	n/a
AL9402B00W	bag	20	n/a

STAIR ANGLE ADAPTOR

for use with pre-drilled RAILSIMPLE railing on standard 7/11 rise/run = 32.5°

Stair Angle Adaptor Black

AL9400B00W	bag	15	n/a
------------	-----	----	-----

DECORATIVE BALUSTER COLLARS

Spiral Collar - Black
Ring Collar - Black

AL9310B00W	pack	1	480
AL9320B00W	pack	2	660

MID-RAIL SUPPORT BRACKET

Recommended on all rail sections over 6 ft

Mid-Rail Support Bracket - silver

HW9411500W	ea	1	n/a
------------	----	---	-----

SOLAR POST CAP LIGHTS

fits up to a 3-1/2" x 3-1/2" post or use as a garden light
Rechargeable batteries included (must be fully charged before initial use)

Solar Post Cap Light - Black
Solar Post Cap Light - Copper

		Ctn. Qty.	
SC9201B00W	box	12	288
SC9201C00W	box	12	288



Now your deck railing light can match your garden lights. These solar post cap lights come with a ground stake assembly that allows dual purpose use both a post cap and a matching garden light. These new decorative lights open up a variety of design options for your outdoor living space allowing you to create a truly distinctive and unique design

Porch Posts add charm and personality to walkways, landings, decks, and porches. There's nothing like the beauty of real wood turnings to add distinction, character, and value to a building project.

PORCH POSTS

VISIT WWW.RAILSIMPLE.COM FOR INSTALLATION INSTRUCTIONS



TREATED

- 4-1/8 x 8 ft Colonial
- 5-1/8 x 8 ft Colonial

WESTERN RED CEDAR

- 4-1/8 x 8 ft Colonial
- 5-1/8 x 8 ft Colonial

PRIMED

- 3-1/4 x 8 ft Colonial
- 4-1/8 x 8 ft Colonial
- 5-1/8 x 8 ft Colonial
- 4-1/8 x 9 ft Colonial
- 5-1/8 x 9 ft Colonial

Order Code BWC SKU#	A	B	C	Unit Qty	Bundle Qty	Pallet Qty
AT3158008W	14"	40 1/8"	41 7/8"	ea	1	30
AT3168008W	14"	40 1/8"	41 7/8"	ea	1	24
CE3158008W	14"	40 1/8"	41 3/8"	ea	1	27
CE3168008W	14"	40 1/8"	41 3/8"	ea	1	28
PP3148008C	14"	40 1/8"	41 7/8"	ea	2	48
PP3158008C	14"	40 1/8"	41 7/8"	ea	1	27
PP3168008C	14"	40 1/8"	41 7/8"	ea	1	28
PP3059009C	24"	40 1/8"	43 7/8"	ea	1	30
PP3069009C	24"	40 1/8"	43 7/8"	ea	1	24

POST FASTENERS

- 4" Quick Mount Porch Post Fastener
 - 5" Quick Mount Porch Post Fastener
 - 6" Quick Mount Porch Post Fastener
- Must be used to maintain porch post warranty*

HW9510000W	ea	10	n/a
HW9511000W	ea	10	n/a
HW9512000W	ea	10	n/a

LOAD BEARING SPECIFICATIONS

Size	Load Bearing	Construction
3 1/4"	1,000 lbs.	Engineered -- FJ/Laminated
4 1/8"	3,000 lbs.	Engineered -- FJ/Laminated
5 1/8"	5,800 lbs.	Engineered -- FJ/Laminated

Quick-Mount Porch Post Fastener

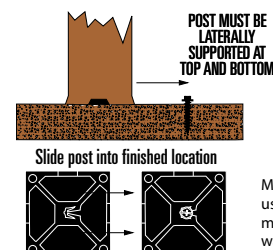

WESTERN RED CEDAR

Cedar has long been recognized as nature's perfect wood for outdoor use with centuries of proven performance.

Our premium clear kiln dried cedar is naturally decay resistant, resists warping, twisting and splitting. Western Red Cedar is prized for its beauty, rich color and smooth tight grain.



278
Dual slot
Plow - 2 1/16" x 3 1/4"

201
Dual slot
Plow 1 7/16" x 2 1/4"

for 1 7/16" spindles
(20 holes 4 3/16" on centre)*
* achieves less than 4" spacing
between appropriate sized spindles.

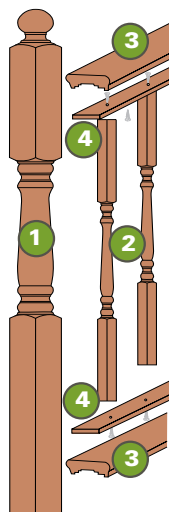

- 1 Cedar newel post
- 2 Cedar Spindles
- 3 Cedar Rails
- 4 Cedar assembly strip

CEDAR NEWEL POSTS

SPINDLES



Colonial
1 1/16"

Corner Fluted
2 1/4"

Colonial
2 1/4"

Contemporary
2 pc. lam.
3 1/4" x 54"

Colonial Balltop
3 1/4" x 48"

By choosing from our wide range of decorative post caps you can add a distinctive look to any deck.

WESTERN RED CEDAR



Copper Point

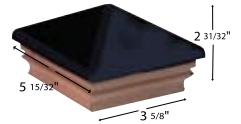

Black Tusk

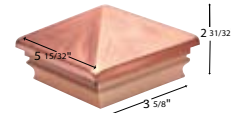

Whistler Peak

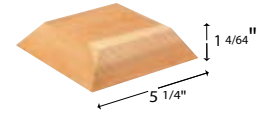

Flat Cap



Wood Pyramid

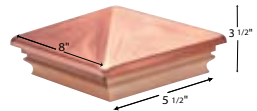

Whistler Peak 6x6

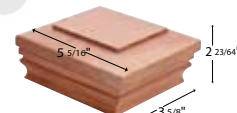

Wood Plateau



Westcoast

SPINDLES - KD CLEAR

1-7/16 x 36" Colonial
2-1/4 x 36" Colonial
2-1/4 x 36" Corner Fluted

Order Code
BWC SKU#
CE5095036W
CE6090036W
CE6004036W

Unit
ea
ea
ea

Box Qty
35
12
12

Pallet Qty
280
96
96

NEWEL POSTS - KD

3-1/4 x 54" Contemporary (2 pc lam)
3-1/4 x 48" Colonial Ball Top

CE9106054W
CE4200048W

ea
ea

Box Qty
6
6

48
48

RAILS

1-3/8 x 3-1/8 x 6 ft 201 Rail (Dual Slot)
1-3/8 x 3-1/8 x 8 ft 201 Rail (Dual Slot)
1-3/8 x 4-15/16" x 6 ft 278 Rail (Dual Slot)
1-3/8 x 4-15/16" x 8 ft 278 Rail (Dual Slot)

CE201HS06A
CE201HS08A
CE278VS06A
CE278VS08A

ea
ea
ea
ea

Box Qty
6
6
2
2

72
72
72
72

RAIL ACCESSORIES

Spindle Assembly Railing Strip for 1-7/16" spindles

CE336E508L

ea

Bundle Qty
5
360

DECORATIVE POST TOPS

Westcoast Ball Top
5-1/8" Flat Cap
Wood Pyramid 4x4 (fits up to 3-1/2" post)
Whistler Peak 4x4 (fits up to 3-1/2" post)
Black Tusk 4x4 (fits up to 3-1/2" post)
Wood Plateau 4x4 (fits up to 3-1/2" post)
Copper Point 4x4 (fits up to 3-1/2" post)
Whistler Peak 6x6 (fits up to 5-1/2" post)

CE7040000W
CE9906000W
CE9902100W
CE9903000W
CE9903500W
CE9907000W
SC9200000W
CE9903200W

ea
ea
ea
ea
ea
ea
ea
ea

Box Qty
14
16
12
12
12
12
36
6

1008
1152
432
432
432
432
1620
180

TREATED

Our Treated Series features Western Lodge Pole Pine which is a slow growing, fine grain species of wood. This means it is more stable, with significantly less warping, twisting or bowing.

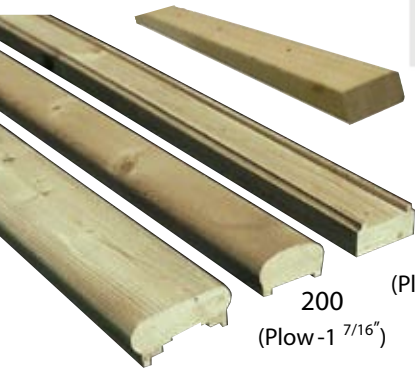

Pre-drilled assembly strip for 1-7/16" spindles
(20 holes 4-3/8" on center).
Achieves less than 4" spacing between spindles

201
Triple slot
(Plow-1 7/16", 1 5/8", 2 1/4")

200 (Plow-1 7/16")
213 (Plow-1 7/16")

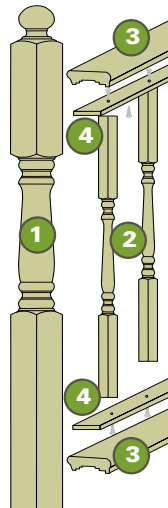

- 1 Treated newel post
- 2 Treated Spindles
- 3 Treated Rails
- 4 Treated assembly strip

TREATED NEWEL POSTS



Colonial
1 7/16"

Colonial
2 1/4"

Colonial
Balltop
3 1/4" x 48"

Colonial
Flattop
3 1/4" x 54"

Deck Post
Notched
3 1/4" x 54"

ACQ treated, this product is design to last, whether left raw or painted to match your décor.

TREATED

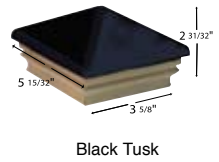
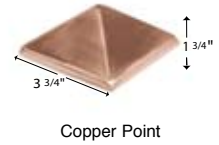
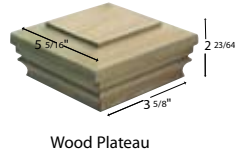
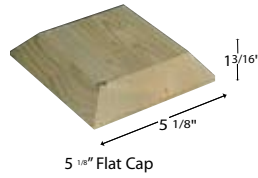

SPINDLES

- 1-7/16 x 36" Colonial
- 2-1/4 x 36" Colonial

Order Code	Unit Qty	Bundle Qty	Pallet Qty
BWC SKU#	ea	10	250
AT5095036W	ea	8	200

NEWEL POSTS

- 3-1/4 x 54" Colonial Flat Top
- 3-1/4 x 48" Colonial Ball Top
- 3-1/4 x 54" Deck Post - Notched

Order Code	Unit Qty	Bundle Qty	Pallet Qty
AT4100054W	ea	4	48
AT4200048W	ea	4	48
AT9100054W	ea	4	72

RAIL

- 1-1/4 x 2-1/4 x 8 ft 200 Hand Rail
- 1-1/4 x 2-1/4" x 8 ft 213 Shoe Rail
- 1-3/8 x 3-1/8" x 8 ft 201 Rail (Triple Slot)
- 1-3/8 x 3-1/8" x 12 ft 201 Rail (Triple Slot)

Order Code	Unit Qty	Bundle Qty	Pallet Qty
AT200IS08A	ea	6	72
AT213IS08A	ea	6	72
AT201ZS08A	ea	5	60
AT201ZS12A	ea	5	60

RAIL ACCESSORIES

- Spindle Assembly Railing Strip for 1-7/16" spindles

Order Code	Unit Qty	Bundle Qty	Pallet Qty
AT336ES08L	ea	5	360

DECORATIVE POST TOPS

- Squared
- Westcoast Ball Top
- 5-1/8" Flat Cap
- Wood Plateau 4x4 (fits up to 3-1/2" post)
- Wood Pyramid 4x4 (fits up to 3-1/2" post)
- Copper Point 4x4 (fits up to 3-1/2" post)

Order Code	Unit Qty	Bundle Qty	Pallet Qty
AT7020000W	ea	8	576
AT7040000W	ea	12	864
AT9906000W	ea	16	1152
AT9907000W	ea	12	432
AT9902100W	ea	12	432
SC9200000W	ea	36	1620

EXTERIOR PRIMED

Always build from the base up. Starting with a premium factory prime coat not only significantly reduces time and labor in preparing your components for painting, it ensures that you start with a premium quality base prime coat which you can apply your premium quality exterior paint. Any surface coating can only provide protection if it is maintained at all times.



BlueLinx

PRIMED NEWEL POSTS

PRIMED SPINDLES

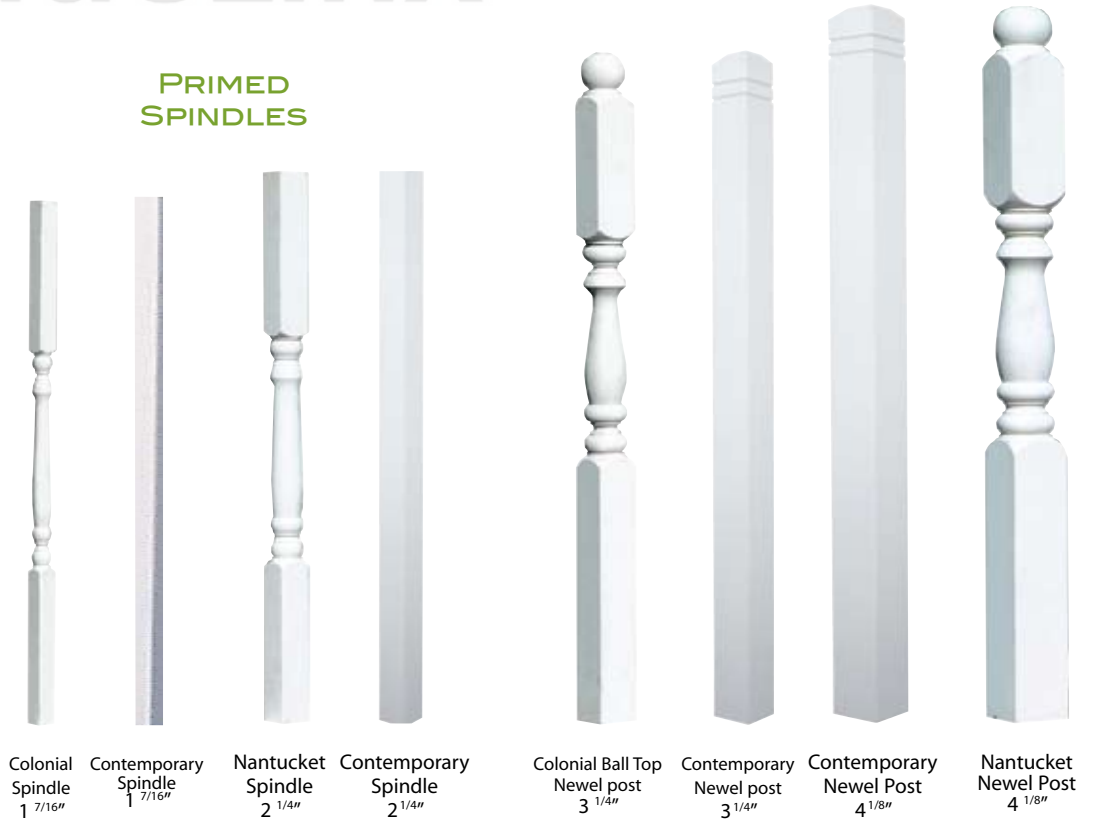

Therefore immediately re-prime and seal any surfaces that are cut or punctured with a high quality exterior primer followed by a high quality exterior top coat allowing each surface to dry before applying the next. Surface holes (nails or screws) can be sealed with a high quality exterior caulking.

EXTERIOR PRIMED

1 Install newel posts

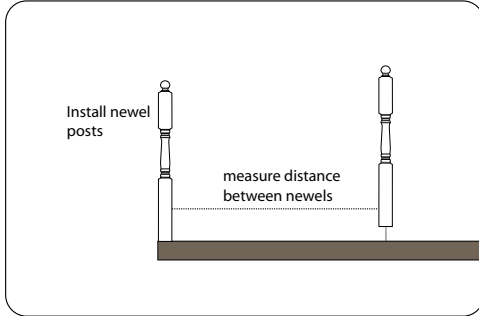

2 Assemble railing section

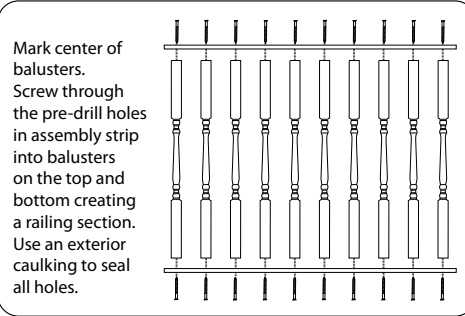

3 Install top and bottom rails

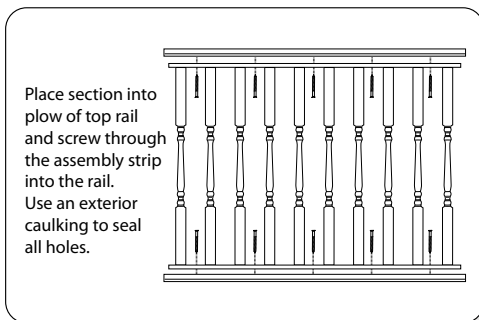

4 Install completed railing section

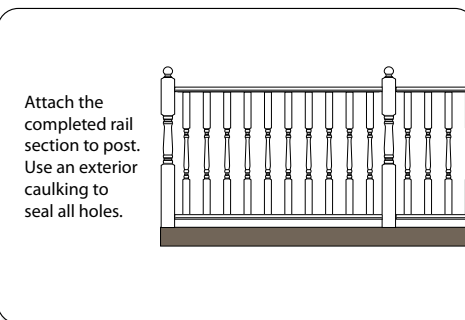

SPINDLES

- 1-7/16 x 36" Colonial
- 1-7/16 x 36" Contemporary
- 2-1/4 x 36" Nantucket
- 2-1/4 x 36" Contemporary

NEWEL POSTS

- 3-1/4 x 48" Colonial Ball Top
- 3-1/4 x 48" Contemporary
- 4-1/8 x 48" Nantucket
- 4-1/8 x 48" Contemporary

RAIL

- 1-3/8 x 3-1/8 x 8 ft 201 Rail (Triple Slot)
- 1-3/8 x 3-1/8 x 12 ft 201 Rail (Triple Slot)
- 1-3/8 x 3-15/16 x 8 ft 237 Rail

RAIL ACCESSORIES

- Assembly Railing Strip for 1-7/16" spindles
- Assembly Railing Strip for 2-1/4" spindles

Order Code	Unit Qty	Bundle Qty	Pallet Qty
BWC SKU#			
LP5095036C	ea	35	280
LS36E0036C	ea	35	280
LP6095036C	ea	12	96
LSS7E0036C	ea	12	96
LP4200048C	ea	6	48
LP9104048C	ea	6	48
LP4950048C	ea	1	48
LP9105048C	ea	1	48
LP201ZS08C	ea	6	72
LP201ZS12C	ea	4	72
LP237JS08A	ea	2	72
LP336EB08C	ea	15	360
LP357EB08A	ea	12	360

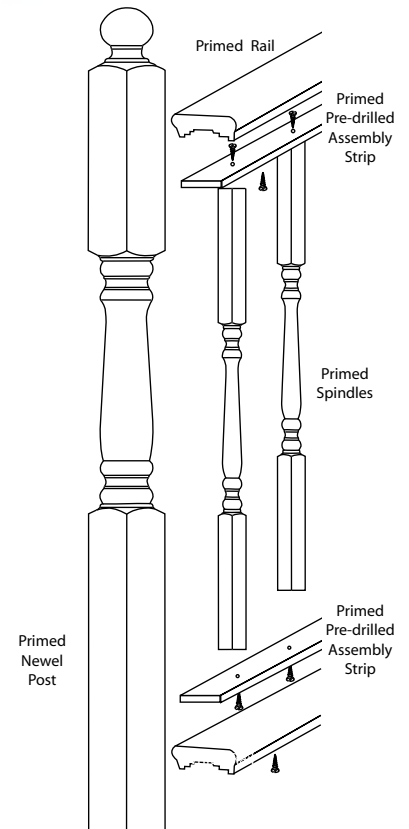

The Axxys™ Railing Kit is revolutionizing the interior stair installation game by simplifying the entire process. Pivoting baluster and rail connectors eliminate complex stair angle calculations and cuts. Pre-drilled railing automatically spaces balusters which speeds and simplifies installation.

VISIT WWW.RAILSIMPLE.COM FOR INSTALLATION INSTRUCTIONS



Railing Kit



KITS

	Order Code BWC SKU#	Unit Qty	Pallet Qty
Hemlock Axxys Stair Rail KIT 15 pcs - 32" Black Balusters 30 pcs - adjustable baluster connectors 2 pcs - adjustable rail connectors 1 pc - Hemlock pre-drilled hand rail (actual length = 95-7/8") 1 pc - Hemlock pre-drilled shoe rail (actual length = 95-7/8")	AXHSR8B32I	Kit	48
Hemlock Axxys Landing Rail KIT 20 pcs - 32" Black Balusters 40 pcs - adjustable baluster connectors 2 pcs - adjustable rail connectors 1 pc - Hemlock pre-drilled hand rail (actual length = 95-7/8") 1 pc - Hemlock pre-drilled shoe rail (actual length = 95-7/8")	AXHLR8B32I	Kit	48

BALUSTERS

	Order Code BWC SKU#	Unit Qty	Ctn Qty	Pallet Qty
32" Black Balusters	AL9300B32W	ctn	10	198

ADJUSTABLE BRACKETS

	Order Code BWC SKU#	Unit Qty	Ctn Qty	Pallet Qty
(pivoting) Axxys™ adjustable baluster bracket - BLACK (10/pkg for 5 balusters)	HW9414B00W	ctn	10	576
Axxys™ adjustable handrail bracket - BLACK (2/pkg for one handrail)	HW9416B00W	box	2	216

PRE-DRILLED AXXYSRAIL

	Order Code BWC SKU#	Unit Qty	Ctn Qty	Pallet Qty
2-1/16 x 2-3/16 x 143-1/2" Hemlock Axxys™ 268 (Pre-drilled) H/R Stair	HE268/T12O	ea	4	216
1-3/16 x 2-3/16 x 143-1/2" Hemlock Axxys™ 269 (Pre-drilled) S/R Stair	HE269/L12O	ea	6	216

NEWEL POST

	Order Code BWC SKU#	Unit Qty	Ctn Qty	Pallet Qty
3-1/4 x 48" Hemlock Double Fluted	HE4412048W	ea	6	144
3-1/4 x 60" Hemlock Double Fluted	HE4412060W	ea	6	144
1-1/2 x 3-1/4 x 48" Hemlock Double Fluted (1/2 Newel)	HE4412048A	ea	2	220

DECORATIVE BALUSTER COLLARS

	Order Code BWC SKU#	Unit Qty	Ctn Qty	Pallet Qty
Spiral Collar - Black	AL9310B00W	pack	1	480
Ring Collar - Black	AL9320B00W	pack	2	660

DECORATIVE POST CAP

	Order Code BWC SKU#	Unit Qty	Ctn Qty	Pallet Qty
Contemporary Hemlock Post Cap	HE9920000W	ea	12	432

The Axxys™ railing system cuts 50% or more of the labor out of a standard interior stair installation and best of all everything you need for the railing section (except posts) are in a single box.

INTERIOR AXXYS™

VISIT WWW.RAILSIMPLE.COM FOR INSTALLATION INSTRUCTIONS



AXXYS™ HANDRAIL

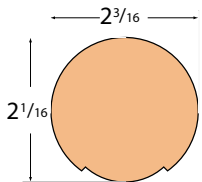

AXXYS™ SHOERAIL

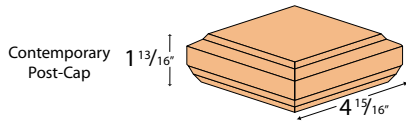
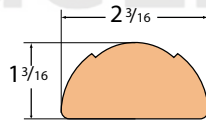

Axxys Baluster Collar - Ring



Axxys Baluster Collar - Spiral

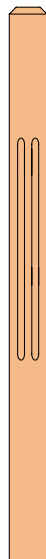

Double Fluted
3 1/4"

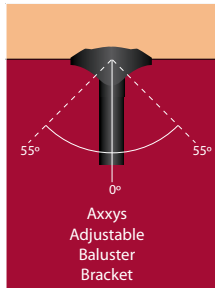
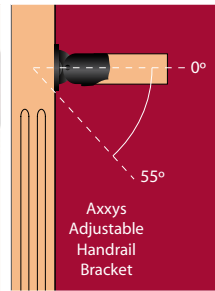

Axxys™ is manufactured / sold under license by BW Creative Wood Industries Ltd

INTERIOR HEMLOCK

Pacific Coast Hemlock is renowned for its fine texture and straight uniform grain. This makes Hemlock the perfect specie for staining, painting or applying a clear varnish to match or compliment any décor.



MISSION



COLONIAL

SPINDLES

- 1-5/8 x 32" Colonial
- 1-5/8 x 36" Colonial
- 1-5/8 x 36" Mission

Order Code BWC SKU#	Unit Qty	Ctn Qty	Pallet Qty
HE5090032W	ea	24	720
HE5090036W	ea	24	720
HE5003036W	ea	24	720

NEWEL POST

- 3-1/4 x 48" Colonial Ball Top
- 3-1/4 x 60" Colonial Ball Top
- 1-1/2 x 3-1/4 x 48" Colonial Ball Top (1/2 newel)
- 3-1/4 x 48" Mission
- 3-1/4 x 60" Mission
- 1-1/2 x 3-1/4 x 48" Mission (1/2 newel)

HE4946048W	ea	6	144
HE4946060W	ea	6	144
HE4946048A	ea	2	220
HE4412048W	ea	6	144
HE4412060W	ea	6	144
HE4412048A	ea	2	220

RAIL

- 1-1/4 x 2-1/4 x 8 ft 200E (1-5/8" plow) Colonial Hand Rail
- 1-1/4 x 2-1/4 x 12 ft 200E (1-5/8" plow) Colonial Hand Rail
- 1-1/4 x 2-1/4 x 8 ft 231E (1-5/8" plow) Colonial Bottom Rail
- 1-21/32 x 2-19/32 x 8 ft 230E (1-5/8" plow) Mission Hand Rail
- 1-21/32 x 2-19/32 x 12 ft 230E (1-5/8" plow) Mission Hand Rail

HE200ES08A	ea	12	360
HE200ES12A	ea	4	192
HE231EB08A	ea	12	360
HE230ES08A	ea	6	216
HE230ES12A	ea	4	192

DECORATIVE POST CAP

- Contemporary Post Cap

HE9920000W	ea	12	432
------------	----	----	-----

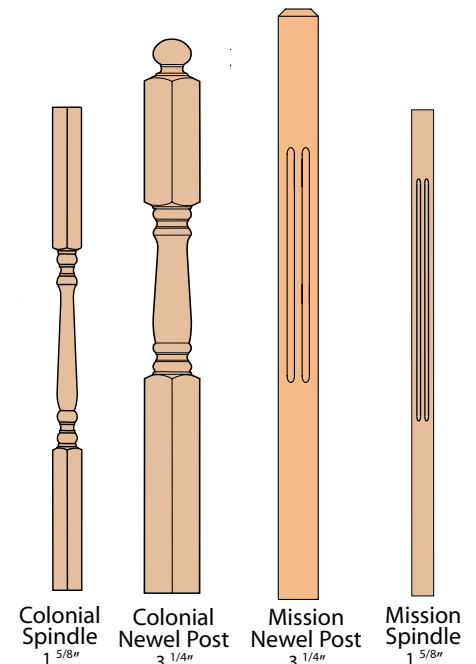
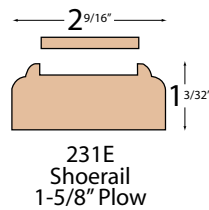
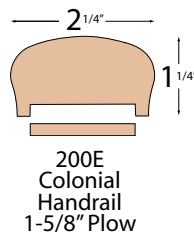
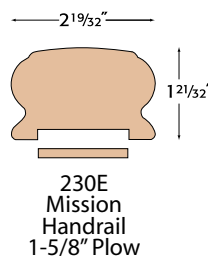
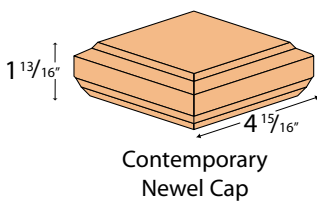

Rail Simple offers a broad range of interior railing styles including the contemporary Mission Series, the classic Colonial series, and the innovative new Axxys™ Railing System which combines Hemlock and powder-coated metal balusters in a do-it-yourself system.

INTERIOR FASTENERS

1 SURE-TITE™ NEWEL FASTENING SYSTEM

The most secure method for mounting newel posts to nished oors.

- Uses floor joists for support
- Installs in as little as 10 minutes
- Needs no mortising or coping
- Will not loosen over time
- Exceeds stair code strength requirement

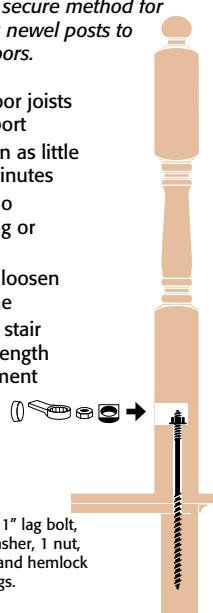

Contains: 1 1" lag bolt, 1 curved washer, 1 nut, 1 1/2" oak and hemlock tapered plugs.

HW9507000W

2 RAIL & POST FASTENER

Fastens hand rails to posts and posts to stairs



Contains: 1 lag bolt, 1 washer, oak and hemlock tapered plugs.

HW9515000W

3 RAIL-BOLT FASTENER

Fastens hand rails to posts and fittings to rails.

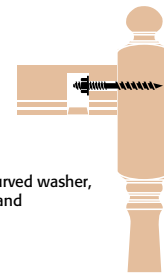

Contains: lag, curved washer, angled nut, oak and tapered plugs.

HW9516000W

4 NEWEL PLATE FASTENER

Use under carpet, over concrete, over finished floors.

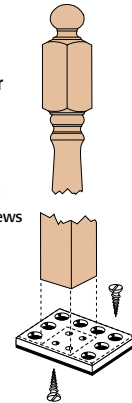

Contains: Heavy 3/16" plate, 13 mounting screws

HW9518000W

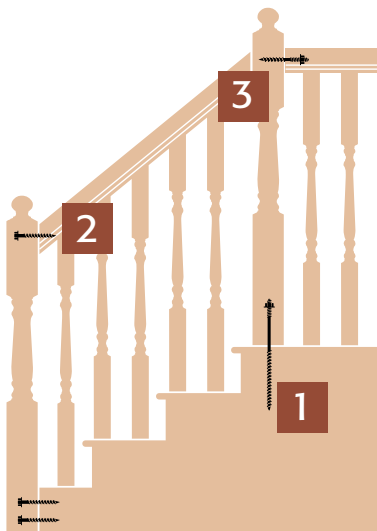

INTERIOR STAIR HARDWARE

- 1 Sure-Tite Newel fastening system
- 2 Rail and Post Fastener
- 3 Rail-Bolt Fastener
- 4 Newel Plate Fastener

Order Code BWC SKU#	Unit Qty
HW9507000W	each
HW9515000W	each
HW9516000W	each
HW9518000W	each

MERCHANDISE RACKS & DISPLAYS

Our Merchandising Racks are designed for use in small spaces presenting the key selling SKU's in a limited 4ft wide by 2ft deep rack. The factory built Displays are also designed to show these key selling product lines in a minimal floor space.

EXTERIOR RAILING CENTER

4 ft wide x 2 ft deep



BR97 – Exterior Railing Components
DP9582200W
Use for – Treated / Cedar / White
Exterior components

INTERIOR RAILING CENTER

4 ft wide x 2 ft deep



BR97 - Interior Railing Components
DP9582100W

DECORATIVE POST TOP CENTER

3 ft wide x 1.5 ft deep

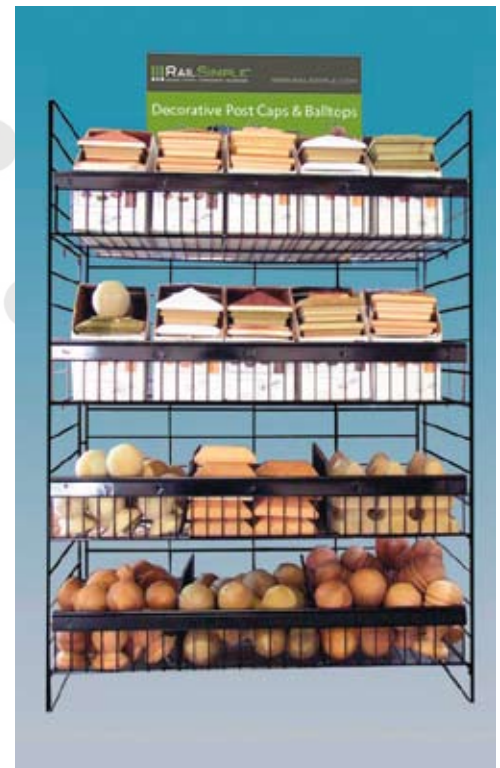

3 ft Post Cap & Ball Top Display Rack
DP9581000W
Use for – Treated / Cedar Decorative
Caps & Ball Tops

Please visit our website for the most up to date and comprehensive listing of our products, features, test reports, and installation instructions. This also includes a listing of installers and dealers available by zip code.

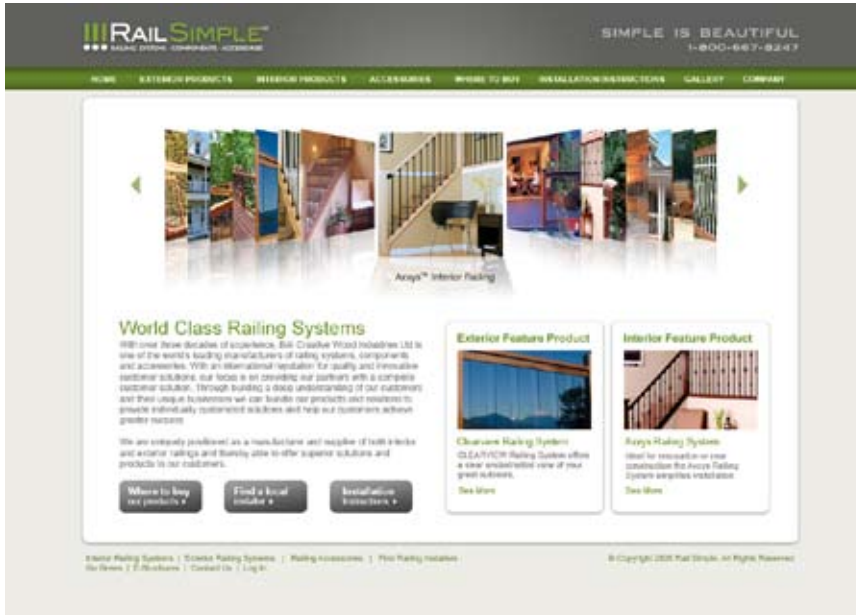

Blue

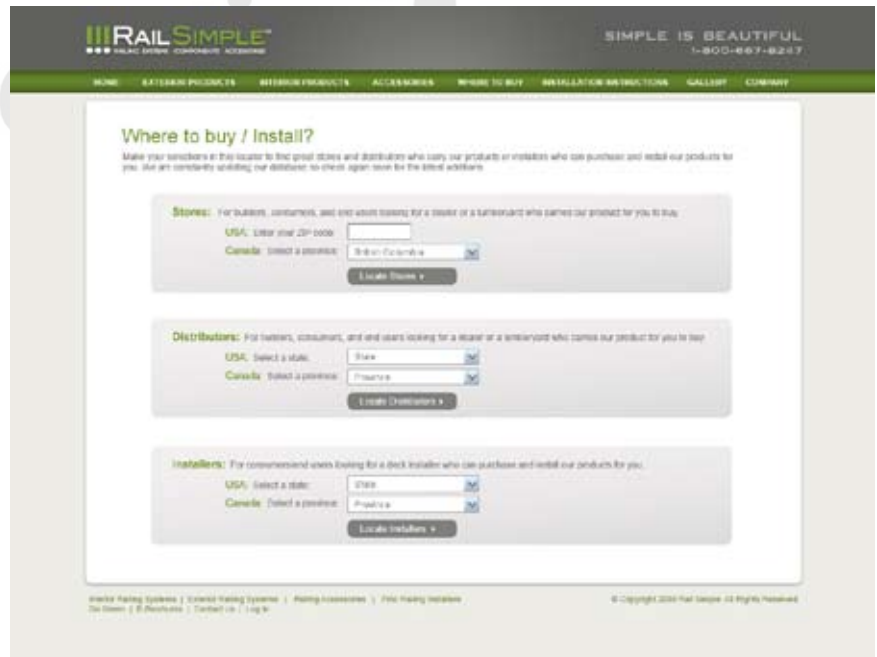

Manufactured by:

B.W. Creative Wood Industries Ltd.
 23282 River Road, Maple Ridge
 British Columbia, Canada V2W 1B6
 Toll free: 1.800.667.8247
 info@railsimple.com

RailSimple Simply BEAUTIFUL

